

**MPFI2H08**

FLOOR FIRE BARRIER

2 HOUR RATED

MAXIMUM OPENING 8" (203mm)

INTERTEK LISTING # BA/EC 120-01

COVER IS REQUIRED TO MAINTAIN  
2 HOUR RATING (BY OTHERS)  
SEE NOTE

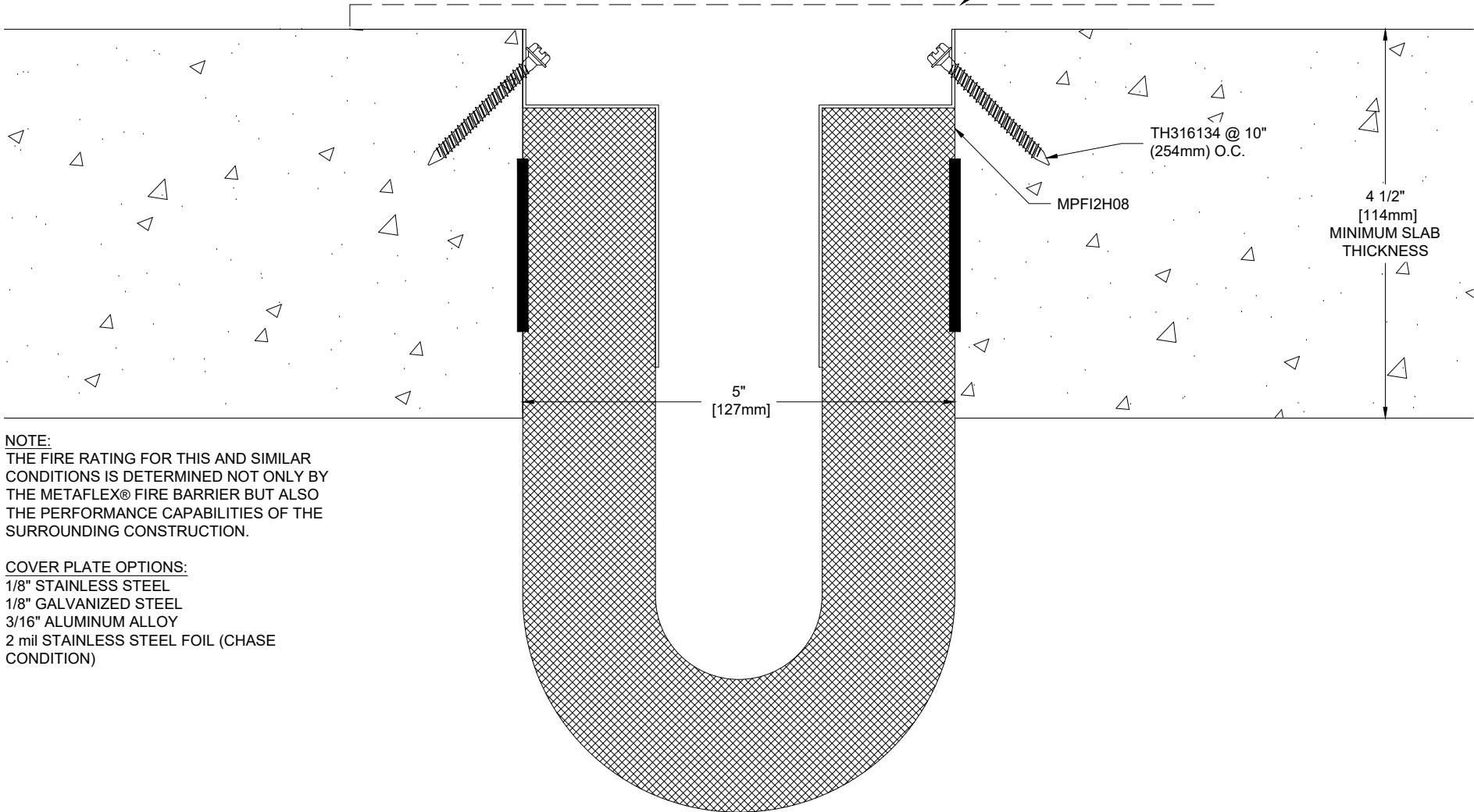

**NOTE:**  
THE FIRE RATING FOR THIS AND SIMILAR  
CONDITIONS IS DETERMINED NOT ONLY BY  
THE METAFLEX® FIRE BARRIER BUT ALSO  
THE PERFORMANCE CAPABILITIES OF THE  
SURROUNDING CONSTRUCTION.

**COVER PLATE OPTIONS:**  
1/8" STAINLESS STEEL  
1/8" GALVANIZED STEEL  
3/16" ALUMINUM ALLOY  
2 mil STAINLESS STEEL FOIL (CHASE  
CONDITION)

Project:	
Customer:	
SO#	
Date:	
Page ___ of ___	Scale: NTS

Length	Qty.	Color

Drawn By: DEB



A CSW Industrials Company

The information contained herein is the proprietary property  
of BALCO®. No portion of it may be reproduced by any means or  
used in any form except for the purpose for which it was furnished.  
All rights of design and invention are hereby reserved.

REV. - 07/14/20