

75FP-2 x 2

INTERIOR FLOOR TO FLOOR SYSTEM
MILL FINISH ALUMINUM BASE
APPROXIMATELY 25% MOVEMENT

COLOR: _____
FILLER COLORS AVAILABLE:
BLACK, GRAY, TAN, OR BRONZE
PLEASE SPECIFY
NOTE: ONLY BLACK IS UV
RESISTANT (FOR EXTERIOR USE)

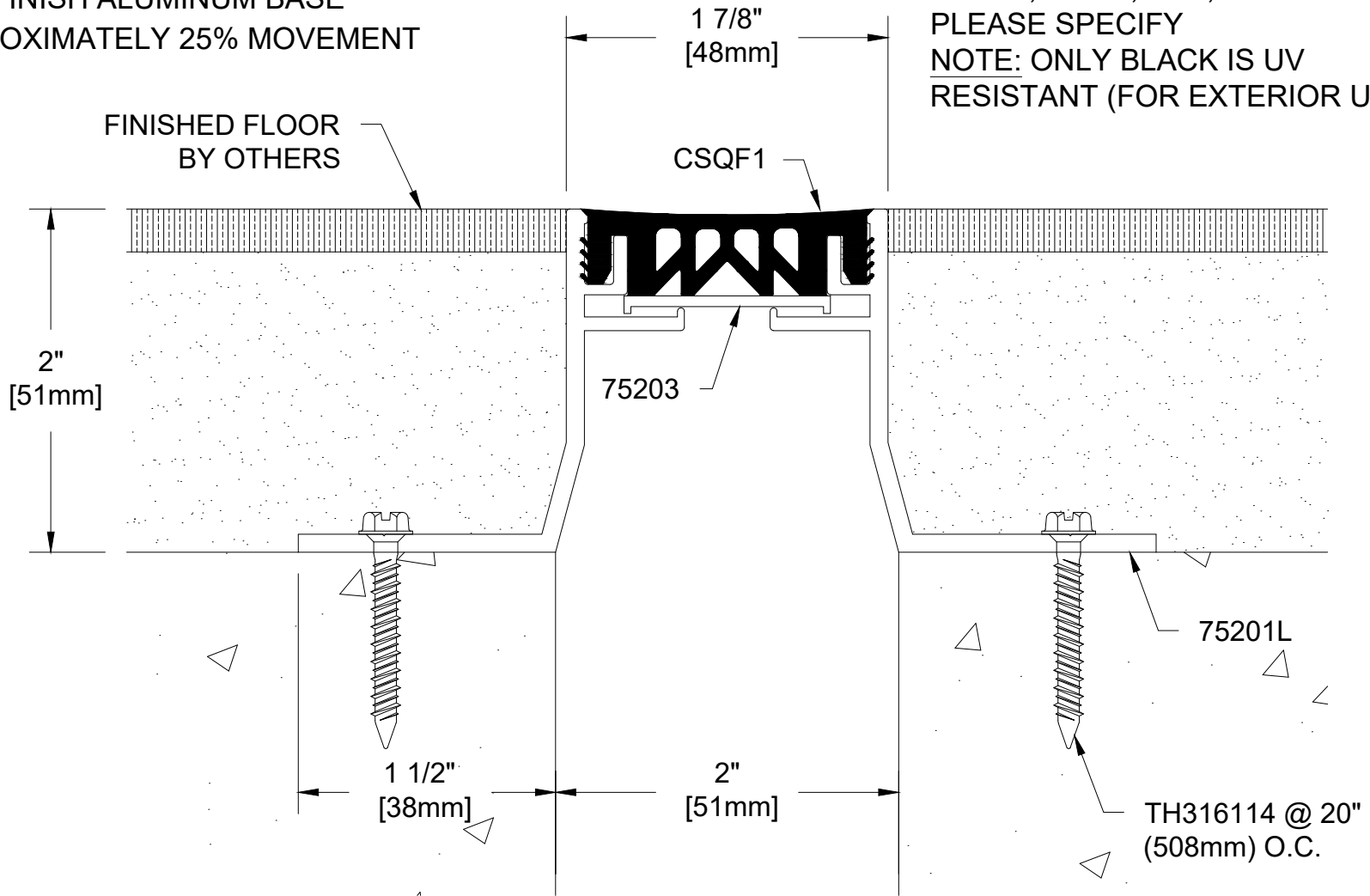

Project:	
Customer:	
SO#	
Date:	
Page ___ of ___	Scale: NTS

Length	Qty.	Color

Drawn By: RJT

The information contained herein is the proprietary property of **BALCO, INC.** No portion of it may be reproduced by any means or used in any form except for the purpose for which it was furnished. All rights of design and invention are hereby reserved.



410 E 37th St N, Suite A
Wichita, Kansas 67219 USA
P: +1-316-945-9328 F: +1-316-945-0789